



## Applications Note

Controlling a Pegasus™  
Prober from a Keysight  
B1500A tester

## Controlling a Pegasus™ Prober from a Keysight B1500A tester

---

*The Keysight B1500A tester has an in-built Windows PC running a control application called EasyExpert. Drivers can be written that allow EasyExpert to control semi-automatic probers such as the Wentworth Pegasus™ series. These drivers consist of three programs, one to load and align a wafer, one to step to the next die on the wafer and the last to unload the wafer. This document describes how to configure the systems and use these drivers.*

---

This document covers the basics of setting up and using the EasyExpert drivers for a Wentworth Laboratories Pegasus™ prober with LabMaster™ software. It is assumed that the reader is familiar with the operation of the tester and Pegasus™ (and if used, LabMaster™).

Note: This document is intended to supplement the Pegasus™ prober's user manual, and should be read with that manual.

### Contents

1. System Requirements.....	3
2. Installation .....	3
3. Configuration .....	4
Keysight B1500A GPIB.....	4
LabMaster/PC .....	5
Easy Expert Driver .....	6
4. Connecting Directly to a Pegasus™ prober via GPIB.....	7
5. Connecting to LabMaster via GPIB .....	8
6. Connecting directly to a Pegasus™ prober via RS232 .....	10
7. Connecting to LabMaster™ via DDE .....	11
8. Addendum.....	13

## 1. System Requirements

The B1500A has a GPIB interface that is used to communicate directly to the Pegasus™ controller or to a computer running LabMaster™ (with LabMaster™ then controlling the prober via RS232). Also, if an external USB to RS232 adapter is used, the tester can control the prober directly via this; and, if LabMaster is installed on the B1500A, EasyExpert can communicate with LabMaster™ via DDE and LabMaster™ can control the prober via the RS232 adapter.

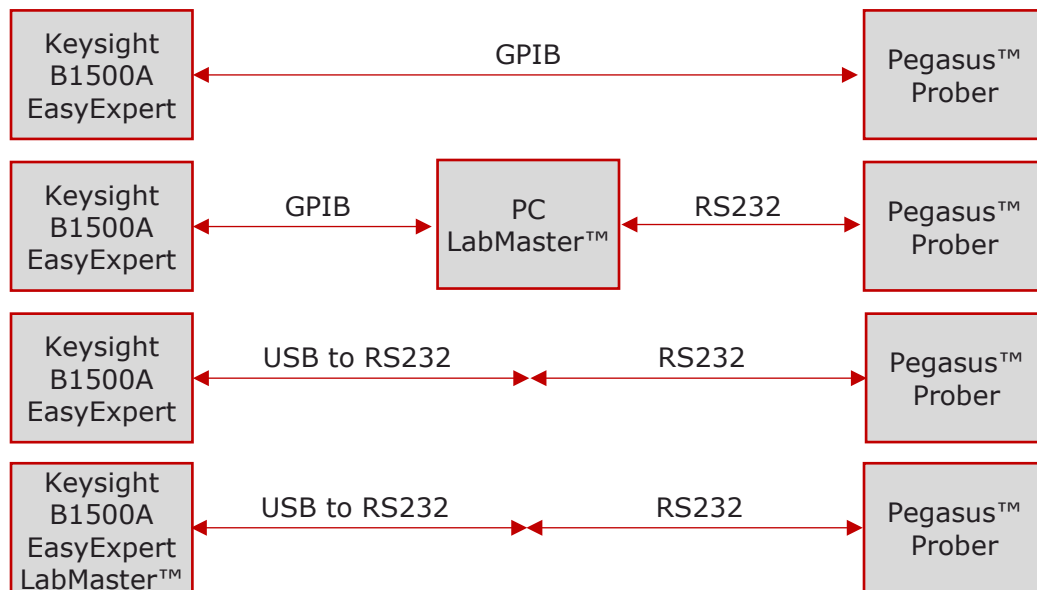

## 2. Installation

The Pegasus™ drivers for EasyExpert are installed on the Keysight B1500A from the supplied installation CDROM. Put the disk in the Keysight's optical drive and using Windows Explorer run *EasyExpert Drivers.exe*. Then follow the on-screen instructions.

By default, the drivers are configured as if LabMaster™ is also installed on the B1500A. If you are using a different configuration, see the following section for configuring the drivers for your specific setup.

### 3. Configuration

#### Keysight B1500A GPIB

The *Keysight Connection Expert* is used to configure the tester's GPIB port to be the system controller and for it to recognize the prober/LabMaster™.

Start up the *Keysight Connection Expert* and edit the properties of the GPIB interface so that it looks like this:

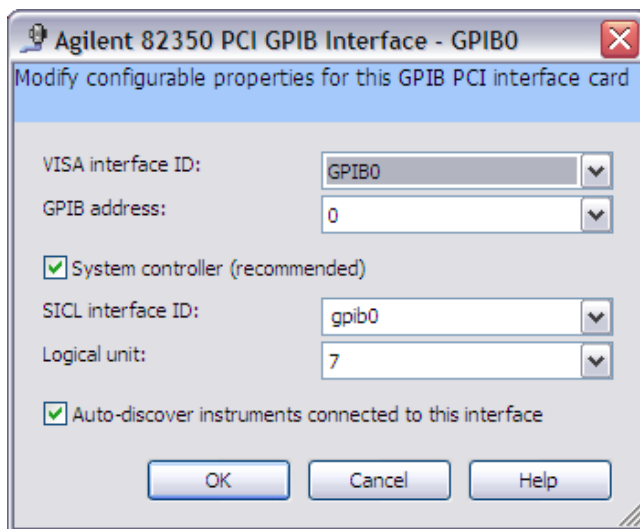

Then add a new instrument corresponding to either the Pegasus™ controller or the LabMaster™ PC. To do this you will need the Pegasus™ or PC's GPIB address, then add an instrument and set its properties as appropriate:



This example is for a connection to a Pegasus™/PC with a GPIB address of 3. This value may be different depending on how you configured the device. Note: *Auto-identify* should NOT be selected as neither the Pegasus™ nor LabMaster™ supports it.

## LabMaster™/PC

If you wish to connect to a prober via PC running LabMaster™, it will be necessary to configure the PC's GPIB card as a slave and to run a REXX script in LabMaster™.

The GPIB card is configured using the NI *Measurement & Automation* application. Set the GPIB0 (PCI\_GPIB) configuration as shown below:

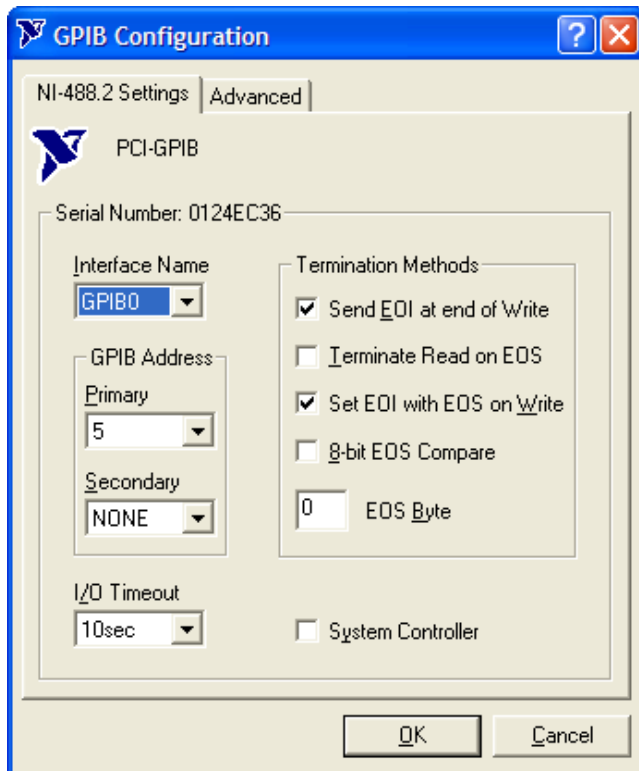

You will also need to run the REXX program GPIB.rex on LabMaster™, this allows REXX commands to be sent to LabMaster™ over the GPIB bus from the B1500A tester. This program is installed into the *Programs\Examples* folder under the LabMaster™ installation folder.

## Easy Expert Driver

The EasyExpert to Pegasus™/LabMaster™ drivers are configured via a file named *prober\_info.ini*. This section gives a brief overview of the important setting in this.

The settings required depend on the communications method used and the setup of the communications ports.

### A. GPIB direct to a Pegasus™

For this you will need to know the GPIB address of the Pegasus™ controller. In the example below this is set to 3. The following entries need to be in the configuration file:

```
[Prober]
Address=GPIB0::3::INSTR
CommsMode=GPIB
[Target]
SubsiteInfo=False
```

### B. GPIB to LabMaster™

For this you will need to know the GPIB address of the LabMaster™ PC. In the example below this is set to 5. The following entries need to be in the configuration file:

```
[Prober]
Address=GPIB0::5::INSTR
CommsMode=GPIB-LM
[Target]
SubsiteInfo=False
```

### C. RS232 direct to a Pegasus™

For this you will need to know the com port of the USB to RS232 adapter and the baud rate set on the Pegasus™ controller. In the example below these are COM3 and 38400 respectively:

```
[Prober]
Address=COM3
CommsMode=RS232
BAUD=38400
[Target]
SubsiteInfo=False
```

### D. DDE to LabMaster™ (RS232 to Pegasus™)

The following entries need to be in the configuration file:

```
[Prober]
CommsMode=DDE-LM
[Target]
SubsiteInfo=False
```

## 4. Connecting Directly to a Pegasus™ prober via GPIB

This section will show you how to use the system to control a Pegasus™ prober directly from a Keysight B1500A tester, via the GPIB interface.

The following instructions assume that the Pegasus™ has been correctly configured with the wafer size, die size, edge sensors (if used), GPIB communications and is in remote mode. For information on how to configure the Pegasus refer to the documentation that came with your prober.

In EasyExpert, select and configure the test you want to perform on each die. Then click on the *repeat* button:

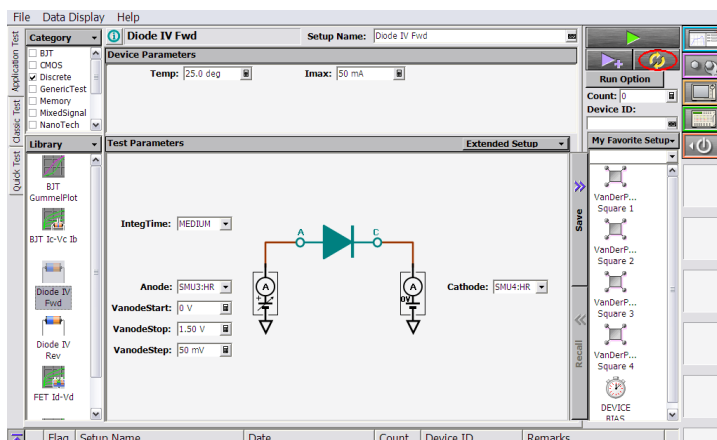

This will display the repeat test setup dialog:

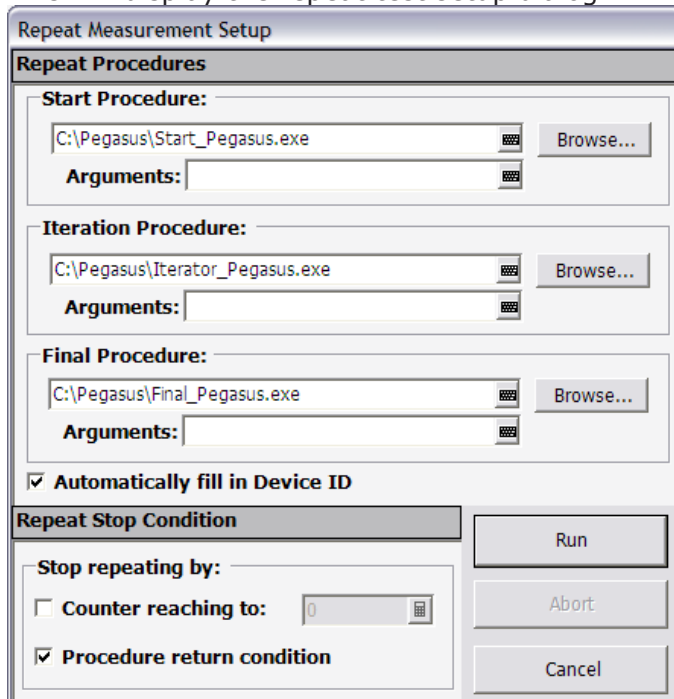

Enter the paths to the driver programs in the Start, Iteration and Final procedure boxes. Usually the stop condition will be as shown above.

To start the test, click on the Run button, the *Start Confirmation* message box is then displayed:

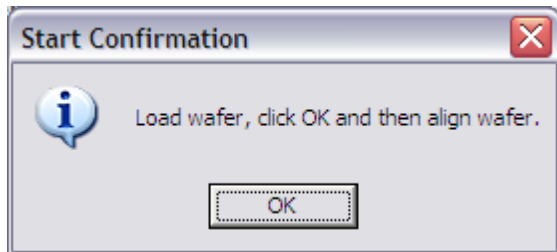

Put the wafer on the chuck and click on *OK*. Then use the Pegasus™ keypad to align the wafer and set the probes to the first die.

The tester will then step around the wafer performing the configured test on each die in turn. When it has finished the wafer can be removed from the chuck.

## 5. Connecting to LabMaster™ via GPIB

This section will show you how to use the system to control a Pegasus™ prober via LabMaster™ from a Keysight B1500A tester using GPIB to communicate between LabMaster™ and the B1500A.

The LabMaster™ PC's GPIB card will need to be configured as a slave and have GPIB.rnx running in LabMaster™ (details in the LabMaster™/PC section of this document on page 5). Also, the appropriate wafer map must be open in LabMaster™.

In EasyExpert, select and configure the test you want to perform on each die. Then click on the *repeat* button:

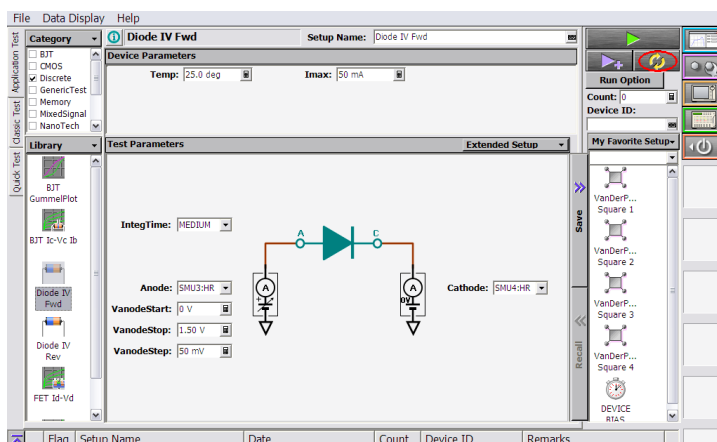



This will display the repeat test setup dialog:

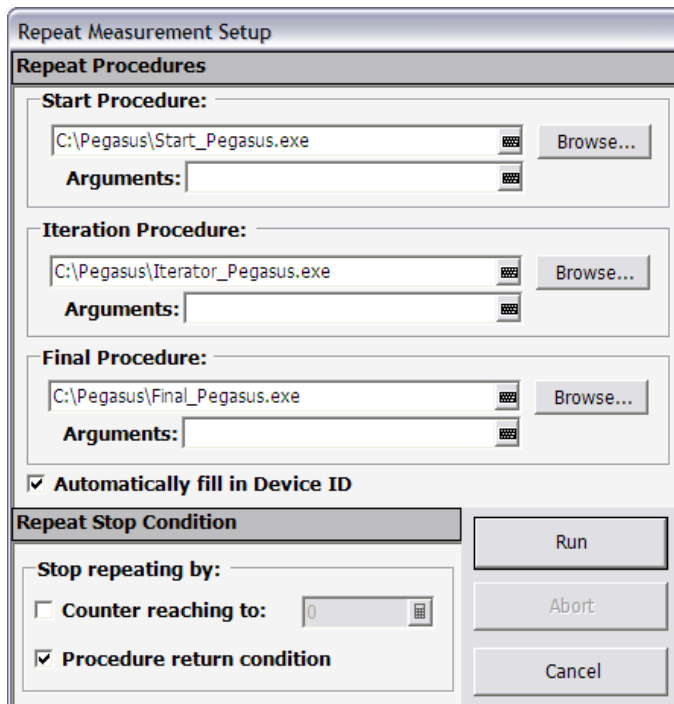

Enter the paths to the driver programs in the Start, Iteration and Final procedure boxes. Usually the stop condition will be as shown above.

To start the test, click on the Run button. The *Start Confirmation* message box is then displayed:

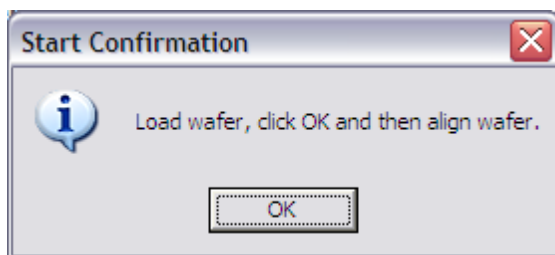

Put the wafer on the chuck and click on *OK*. Use the LabMaster™ controls to perform a two point align. When this has been done, click on *OK* in LabMaster™. Next, align the probes with the first die and again click on *OK* in LabMaster™.

The tester will then step around the wafer performing the configured test on each die in turn. When it has finished, the wafer can be removed from the chuck.

## 6. Connecting directly to a Pegasus™ prober via RS232

This section will show you how to use the system to control a Pegasus™ prober directly from a Keysight B1500A tester via RS232. As the B1500A does not have an external RS232 port, a USB to RS232 adapter is required.

The following instructions assume that the Pegasus™ has been correctly configured with the wafer size, die size, edge sensors (if used), RS232 communications and is in remote mode. For information on how to configure the Pegasus™ refer to the documentation that came with your prober.

In EasyExpert, select and configure the test you want to perform on each die. Then click on the *repeat* button:

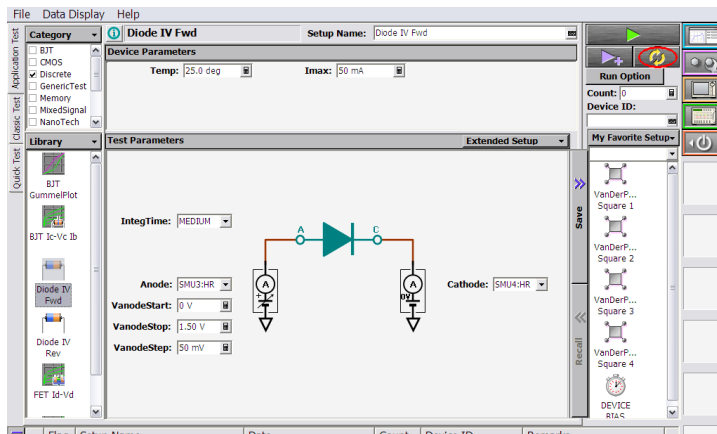

This will display the repeat test setup dialog:

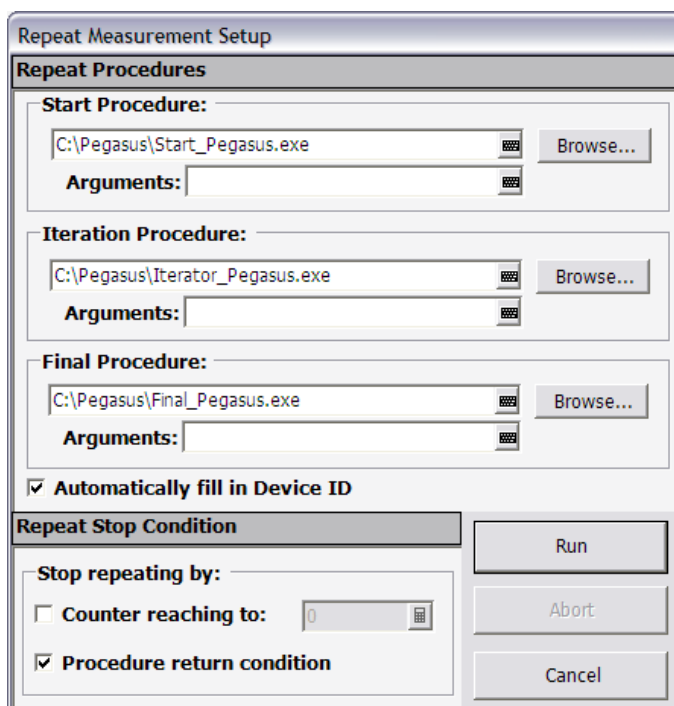

Enter the paths to the driver programs in the Start, Iteration and Final procedure boxes. Usually the stop condition will be as shown above.

To start the test, click on the Run button. The *Start Confirmation* message box is then displayed:

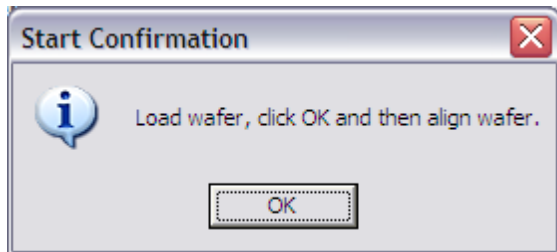

Put the wafer on the chuck and click on *OK*. Then use the Pegasus™ keypad to align the wafer and set the probes to the first die.

The tester will then step around the wafer performing the configured test on each die in turn. When it has finished the wafer can be removed from the chuck.

## 7. Connecting to LabMaster™ via DDE

This section will show you how to use the system to control a Pegasus™ prober via LabMaster™ from a Keysight B1500A tester using DDE communications between LabMaster™ and EasyExpert.

LabMaster™ v8.9.3 or later, first needs to be installed on the B1500A in the same way as on a normal PC. However, it is not possible to install a video capture card in the tester so LabMaster™ cannot show a video image from a prober's microscope. Also, as LabMaster™ can't communicate through the B1500A's GPIB interface, it must be connected to the prober via a USB to RS232 adapter.

LabMaster™ must be running with an appropriate wafer map open before starting the test running in EasyExpert. In EasyExpert, select and configure the test you want to perform on each die. Then click on the *repeat* button:

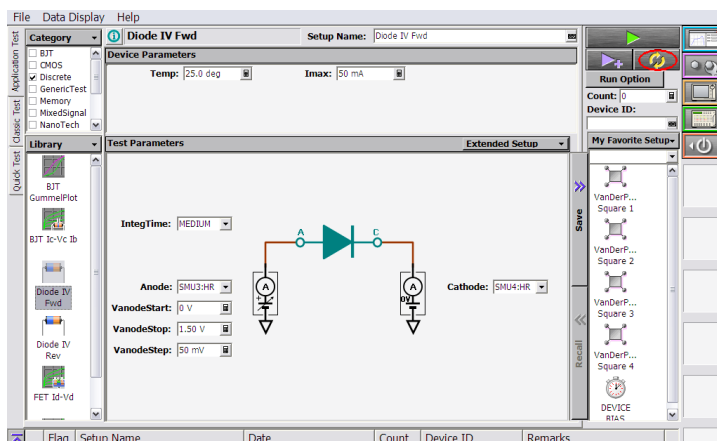

This will display the repeat test setup dialog:

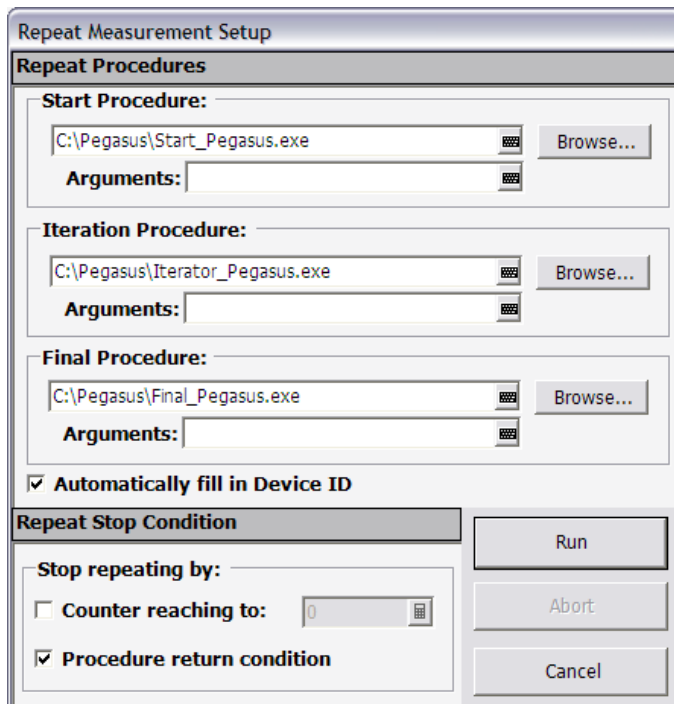

Enter the paths to the driver programs in the Start, Iteration and Final procedure boxes. Usually the stop condition will be as shown above.

To start the test, click on the Run button, the *Start Confirmation* message box is then displayed:

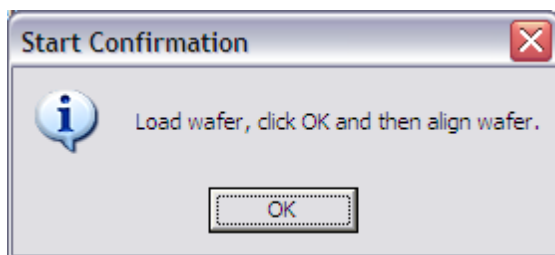

Put the wafer on the chuck and click on *OK*. Then use the Pegasus™ keypad to align the wafer and set the probes to the first die.

The tester will then step around the wafer performing the configured test on each die in turn. When it has finished the wafer can be removed from the chuck.

## 8. Addendum

These drivers were written by Wentworth Laboratories, based on examples and information supplied by Keysight. Wentworth Laboratories wish to thank Keysight for their help and assistance in creating these drivers.

LabMaster™ and Pegasus™ are trademarks of Wentworth Laboratories, Inc. in the US and other countries.